

KA02

ILLUSTRATED ASSEMBLY MANUAL HKA02IP'1

Audio shield for Arduino®



velleman®
projects

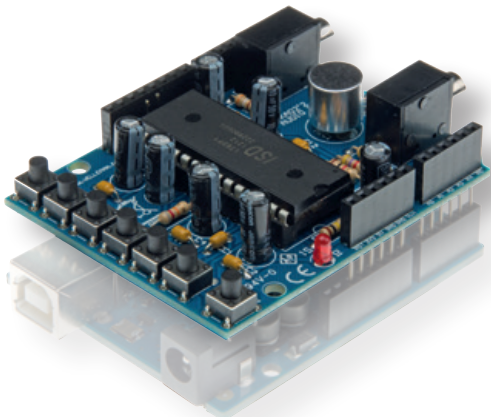

Record your voice via a built-in microphone or a line input.

Features

- For use with Arduino Due™, Arduino Uno™, Arduino Mega™
- Based on ISD1760PY integrated circuit
- With pushbuttons for REC, PLAY, FWD, ERASE, VOL, RESET and FEEDTROUGH
- Built-in microphone
- 3.5mm stereo LINE IN/OUT female jacks
- Speaker output

Specifications

- Recording time: 60s
- Power supply: from Arduino™
- Dimensions: 71 x 53mm / 2.79 x 2.08"



Search product

Search Product

Navigation

- Home page
- Products
- Sales outlets
- Support
- Publications
- Jobs
- About us

News

NEW FM253 LED CUBE

CubeXplorer software available for download [here!](#)

Posted on 04-06-12

[Read more...](#)



Velleman Projects
All about the wireless world
Developments: Kits, Modules,
Instruments and Home Automation

United Kingdom -
English (UK)
Change

Velleman Projects Newsletter

Are you an electronic enthusiast or simply interested in our kits, mini-kits, modules and instruments?

Subscribe to our Newsletter and receive every month the latest news, new products & updates on Velleman Projects.

You will receive an email. Click on the link in that email to confirm your subscription.

Email:



Do you want to unsubscribe? Click on the 'unsubscribe' link in the footer of the last received newsletter from Velleman Projects.

[velleman.eu](#)
[Supporter.eu](#)
[panel.eu](#)
[vellenmanproject.com](#)
[vellenmanproject.com](#)
[vellen.eu](#)
[forum.velleman.eu](#)

Advertisements

[KITKIT / VIKIKit](#)
[Android Application](#)



Subscribing our newsletter?, visit www.vellemanprojects.eu



Participate our Velleman Projects Forum



INSTRUMENTS
KITKIT
KITKIT

Support Forum (ENFR)
vellenmanprojects

ENFR

FR

View unanswered posts | View active posts

49 threads and 472 posts

Thread	Topics	Posts	Last visit
General			
French video: Regardez de beaux Apple TV 2 et de la carte de MicroStation	1	1	Wed Sep 26, 2012 12:44 pm vellenman
French Administration	1	1	Fri May 18, 2012 1:20 pm Bjorn
Software			
Velleman Home Automation General advice for our new Velleman Home Automation System (General) MicroStation	424	2072	Fri Sep 14, 2012 11:10 pm Drems
Kits (Outstanding projects - Projects & boards)			
General For other topics, general tips and tricks, new ideas MicroStation	275	432	Wed Sep 26, 2012 12:37 pm vellenman
Apple TV 2 Upgrade All audio related projects, amplifiers, video amplifiers MicroStation	527	2400	Fri Sep 14, 2012 11:00 am vellenman
Kit: Weather-Projects All projects that are connected to the KIT via interface cards MicroStation	1428	8548	Fri Sep 14, 2012 11:00 am vellenman
MicroStation: Arduino Programming - Experimenting-Programs Next to our own Arduino KIT programming, external soft. MicroStation	467	1744	Fri Sep 14, 2012 11:00 am vellenman
Projects and boards All about our home related projects from regular visitors to programmable bricks MicroStation	281	936	Fri Sep 14, 2012 11:00 am vellenman
Home-Projects MicroStation related projects, from light drivers to remote control MicroStation	624	2282	Fri Sep 14, 2012 11:00 am vellenman



Velleman N.V.
Legen Heirweg 33
9890 Gavere
(België)

assembly hints

1. Assembly (Skipping this can lead to troubles !)

Ok, so we have your attention. These hints will help you to make this project successful. Read them carefully.



1.1 Make sure you have the right tools:

- A good quality soldering iron (25-40W) with a small tip.
- Wipe it often on a wet sponge or cloth, to keep it clean; then apply solder to the tip, to give it a wet look. This is called 'thinning' and will protect the tip, and enables you to make good connections. When solder rolls off the tip, it needs cleaning.
- Thin raisin-core solder. Do not use any flux or grease.
- A diagonal cutter to trim excess wires. To avoid injury when cutting excess leads, hold the lead so they cannot fly towards the eyes.
- Needle nose pliers, for bending leads, or to hold components in place.
- Small blade and Phillips screwdrivers. A basic range is fine.

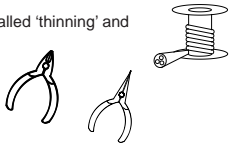

For some projects, a basic multi-meter is required, or might be handy



1.2 Assembly Hints :

- Make sure the skill level matches your experience, to avoid disappointments.
- Follow the instructions carefully. Read and understand the entire step before you perform each operation.
- Perform the assembly in the correct order as stated in this manual
- Position all parts on the PCB (Printed Circuit Board) as shown on the drawings.
- Values on the circuit diagram are subject to changes, the values in this assembly guide are correct*
- Use the check-boxes to mark your progress.
- Please read the included information on safety and customer service

* Typographical inaccuracies excluded. Always look for possible last minute manual updates, indicated as 'NOTE' on a separate leaflet.

1.3 Soldering Hints :

1. Mount the component against the PCB surface and carefully solder the leads



2. Make sure the solder joints are cone-shaped and shiny

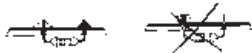

3. Trim excess leads as close as possible to the solder joint



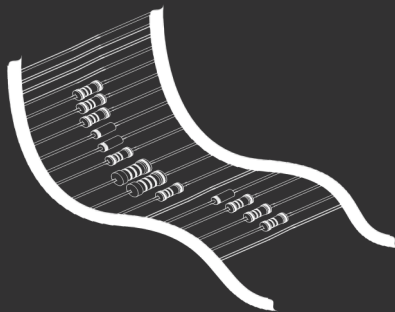

REMOVE THEM FROM THE TAPE ONE AT A TIME !

Included in
this kit

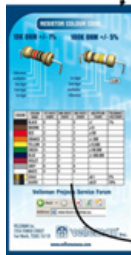

2. RESISTOR

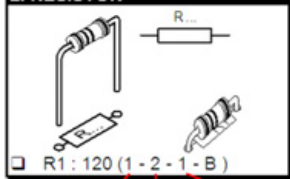

COLOUR	COLOUR NAME	1ST DIGIT/ STRIPE	2ND DIGIT/ STRIPE	3RD DIGIT/ STRIPE	MULTIPLIER STRIPE	TOLERANCE 4TH
Black	BLACK	0	0	0	x1	1%
Brown	BROWN	1	1	1	x10	
Red	RED	2	2	2	x100	
Orange	ORANGE	3	3	3	x1.000	
Yellow	YELLOW	4	4	4	x10.000	
Green	GREEN	5	5	5	x100.000	
Blue	BLUE	6	6	6	x1.000.000	

DO NOT BLINDLY FOLLOW THE ORDER OF THE COMPONENTS ONTO THE TAPE. ALWAYS CHECK THEIR VALUE ON THE PARTS LIST!

1 CONSTRUCTION

1 Resistors

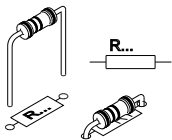

- R1: 1K (1 - 0 - 2 - B)
- R2: 4K7 (4 - 7 - 2 - B)
- R3: 100K (1 - 0 - 4 - B)
- R4: 82K (8 - 2 - 3 - B)
- R5: 4K7 (4 - 7 - 2 - B)
- R6: 4K7 (4 - 7 - 2 - B)
- R7: 390 (3 - 9 - 1 - B)

2 Ceramic capacitors

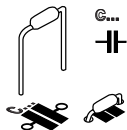

- C1: 100nF (104)
- C2: 100nF (104)
- C4: 100nF (104)
- C6: 100nF (104)
- C8: 100nF (104)
- C12: 100nF (104)
- C13: 100nF (104)
- C16: 100nF (104)
- C17: 100nF (104)

3 LED

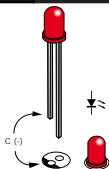

Watch the polarity!

- LD1: Red

4 IC socket

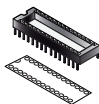

Watch the position of the notch!

- IC1: 28p

5 Push buttons

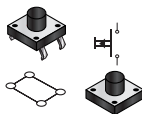

- SW1: Reset
- SW2: Forward
- SW3: Erase
- SW4: Record
- SW5: Play
- SW6: Feed trough
- SW7: Volume

6 Male header

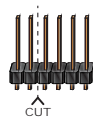

- SK7: 2p

7 Female header

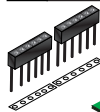

- 2 x 6p

 Do not cut the connector pins!

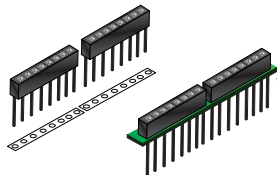
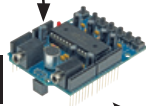

- 2 x 8p

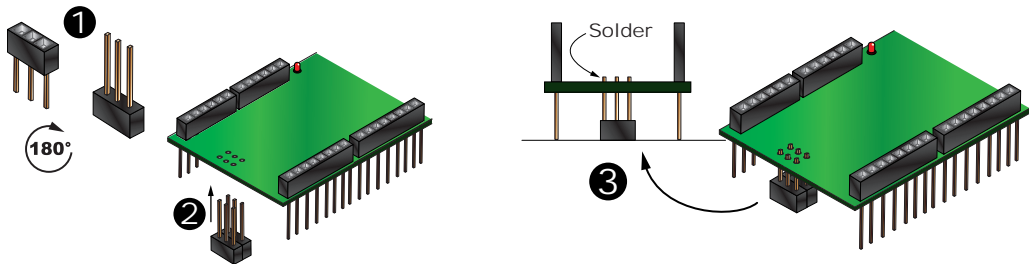

□ SK8: 2 x 3p

8 Microphone

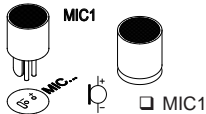

9 Electrolytic capacitors

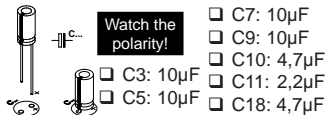

10 Stereo Phone Jack

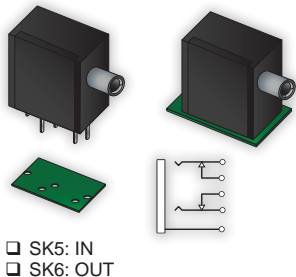

11 IC

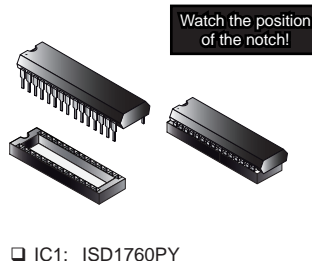

II CONNECTION DIAGRAM

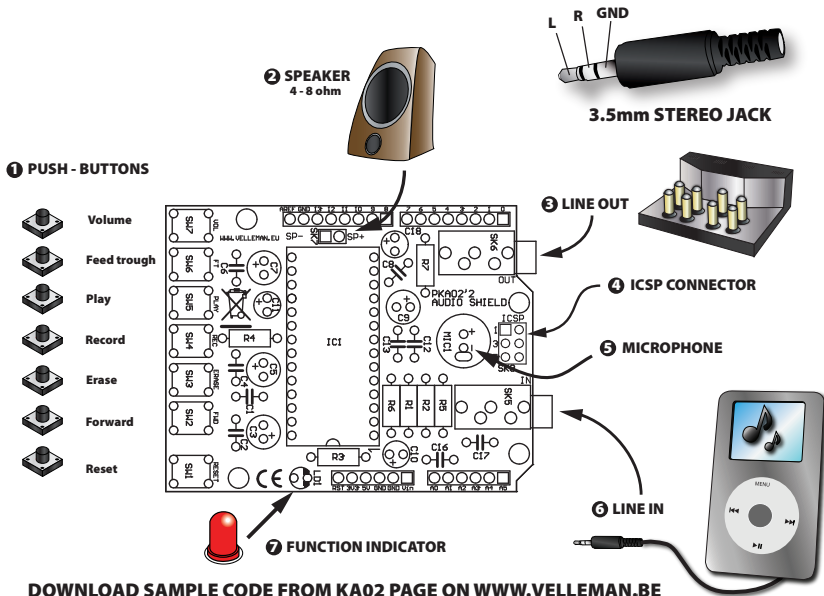

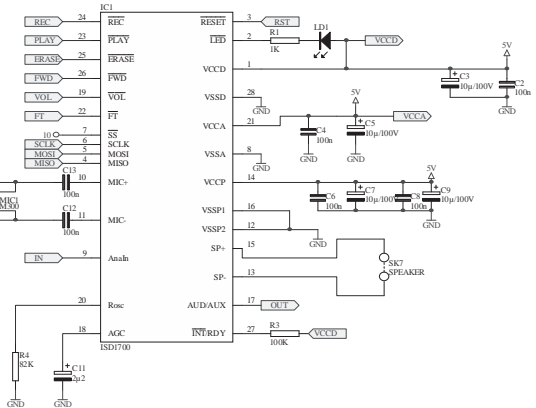
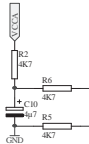
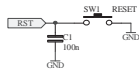
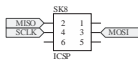
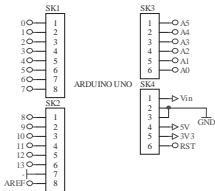
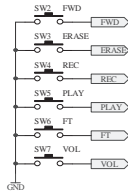
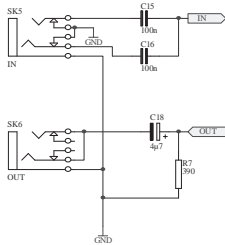

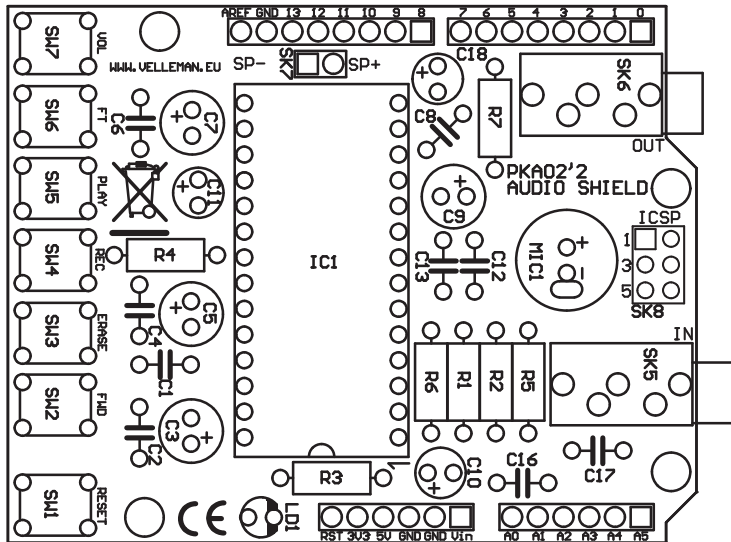

Leds and how to use them

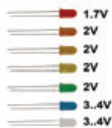

Leds feature a specific voltage drop, depending on type and colour. Check the datasheet for exact voltage drop and rated current !

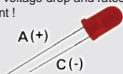

Never connect leds in parallel

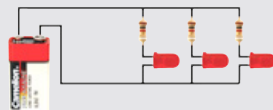
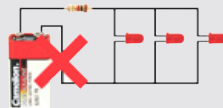

How to Calculate the series resistor:

Example: operate a red led (1.7V) on a 9Vdc source.

Required led current for full brightness: 5mA (this can be found in the datasheet of the led)

$$\frac{\text{Supply voltage (V) - led voltage (V)}}{\text{required current (A)}} = \text{series resistance (ohms)}$$



$$\frac{9V - 1.7V}{0.005A} = 1460 \text{ ohm}$$

closest value :
use a 1k5 resistor

Required resistor power handling=
voltage over resistor x current passed trough resistor



$$(9V - 1.7V) \times 0.005A = 0.036W$$

a standard 1/4W resistor
will do the job

LEDs in series:

Example: 3 x red led (1.7V) on 9V battery
Required led current for full brightness: 5mA
(this can be found in the datasheet of the led)

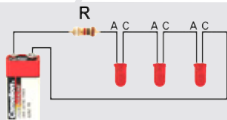

$$\frac{\text{Supply voltage (V) - (number of leds x led voltage (V))}}{\text{required current (A)}} = \text{series resistance (ohms)}$$



$$\frac{9V - (3 \times 1.7V)}{0.005A} = 780 \text{ ohm}$$

use an
820 ohm resistor

open collector outputs

An open collector output can be compared to a switch which switches to ground when operated

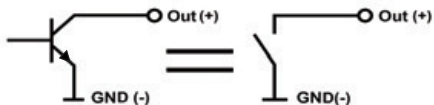

Example: How to switch an LED by means of an open collector output

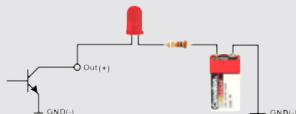



The new Velleman Projects catalogue is now available. Download your copy here:

www.vellemanprojects.eu



Modifications and typographical errors reserved - © Velleman nv. HKA02'IP (rev.1.0)
Velleman NV, Legen Heirweg 33 - 9890 Gavere.